

A5616A - A5616AK

ATTACCHI SPECIFICI PER - SPECIFIC FITTING KIT FOR - KIT DE MONTAGE SPECIFIQUE POUR
SPEZIFISCHER MONTAGEKIT FÜR - ANCLAJE ESPECÍFICO PARA - ANCORADOURO ESPECÍFICO

PIAGGIO BEVERLY 300 HPE(2021)

N°	Descrizione/Description	Caratteristiche/Features	Codice/Code	Quantità/Quantity
1	Supporto - Support - Support Halterung - Soporte - Apoio	-	GNB2643DXV GNB2643SXV	2(Right; Left)
2	Tappo - Cap Fiche - Stecker Enchufe - Capa	LEFT SIDE	Z3604V	1
3	Tappo - Cap Fiche - Stecker Enchufe - Capa	RIGHT SIDE	Z3605V	1
4	Vite - Screw Vis - Schraube Tornillo - Parafuso	TCE M10x90	1090TCE	2
5	Vite - Screw Vis - Schraube Tornillo - Parafuso	TBEI M6x25	625TBEI	4
6	Rondella Inox - Stainless Steel Washer Rondelle Inox - Rostfreie Unterlegscheibe Aus Stahl Arandela Inox - Arruela Lisa De Aço Inox	Foro Ø10mm SP. 1mm	101RON	2
7	Boccola Di Ritenzione - Plastic Bush Douille Plastique - Plastik Buchse Casquillo - Boné	-	Z871N	4
8	Gommino - Fairleader Chaumard - Gummi Goma - Borracha	-	Z268-2	4
9	Componenti Originali - Original Parts Parties Originales - Original Bauteile Componentes Originales - Componentes Originais	-	-	-
10	Schermo Specifico - Specific Screen - Écran Spécifique Spezifischen Bildschirm - Pantalla Específica - Tela Específica	-	5616A	-

A5616A - A5616AK

ATTACCHI SPECIFICI PER - SPECIFIC FITTING KIT FOR - KIT DE MONTAGE SPECIFIQUE POUR
SPEZIFISCHER MONTAGEKIT FÜR - ANCLAJE ESPECÍFICO PARA - ANCORADOURO ESPECÍFICO

PIAGGIO BEVERLY 300 HPE(2021)

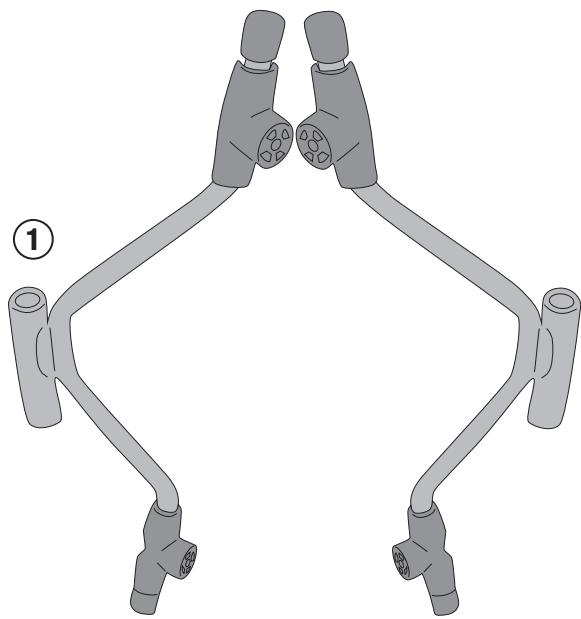

GNB2643DXV/GNB2643SXV

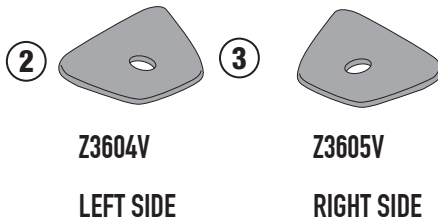

Z3604V

LEFT SIDE

Z3605V

RIGHT SIDE

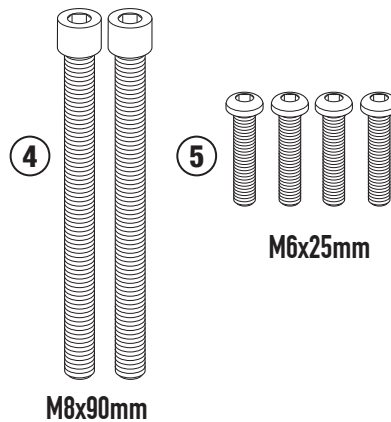

M8x90mm

M6x25mm



Hole Ø10mm/
D.1mm

Z871N

Z268-2

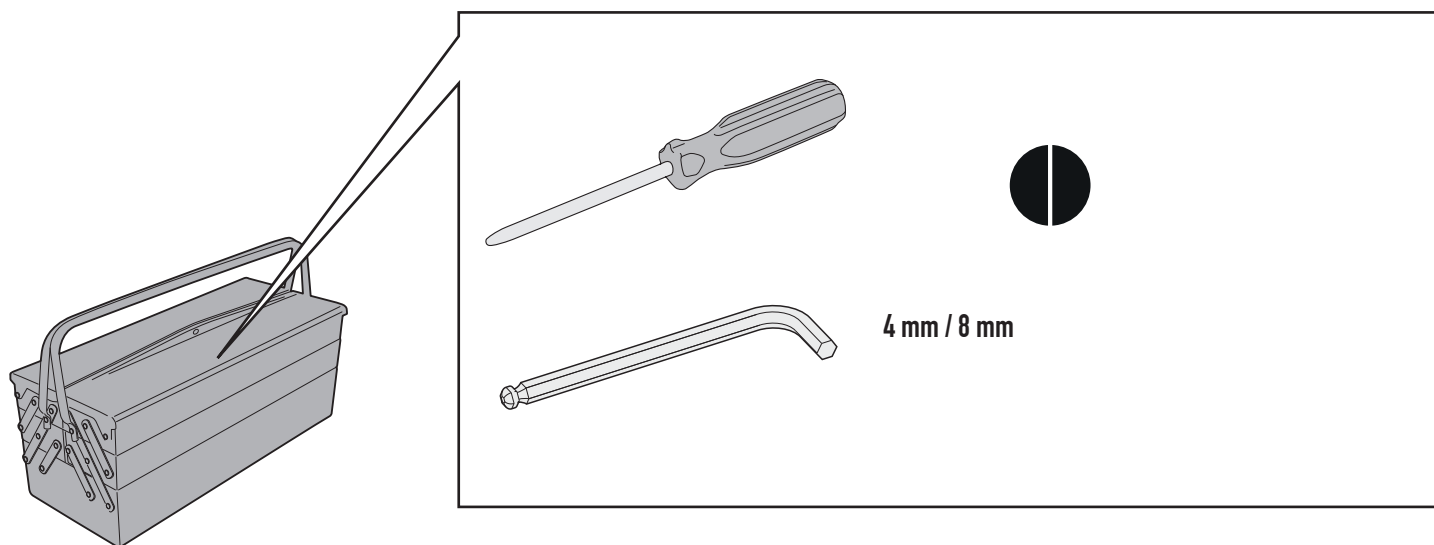

4 mm / 8 mm

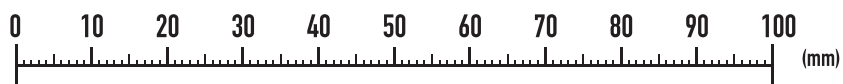

ISTRUZIONI DI MONTAGGIO - MOUNTING INSTRUCTIONS
INSTRUCCIONES DE MONTAJE - BAUANLEITUNG
INSTRUÇÕES DE MONTAJE - INSTRUÇÕES DE MONTAGEM

A5616A - A5616AK

ATTACCHI SPECIFICI PER - SPECIFIC FITTING KIT FOR - KIT DE MONTAGE SPECIFIQUE POUR
SPEZIFISCHER MONTAGEKIT FÜR - ANCLAJE ESPECÍFICO PARA - ANCORADOURO ESPECÍFICO

PIAGGIO BEVERLY 300 HPE(2021)

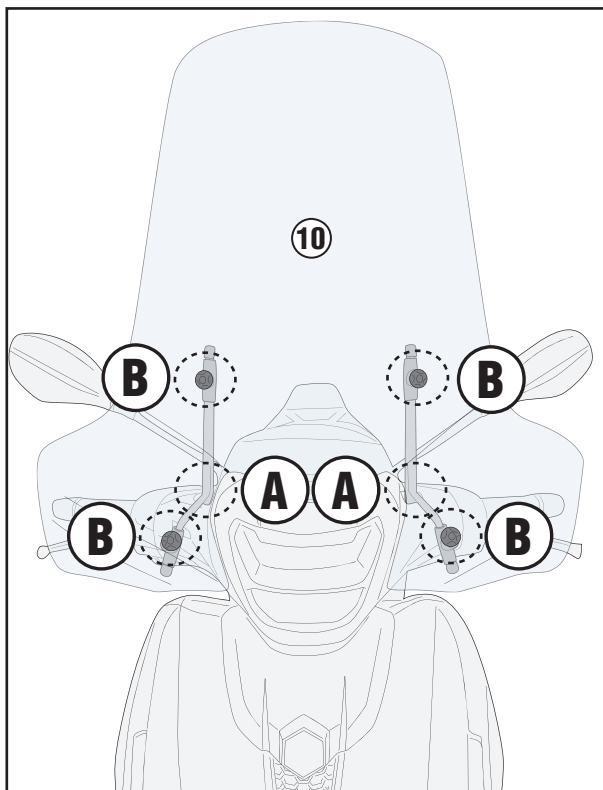

REMOVE

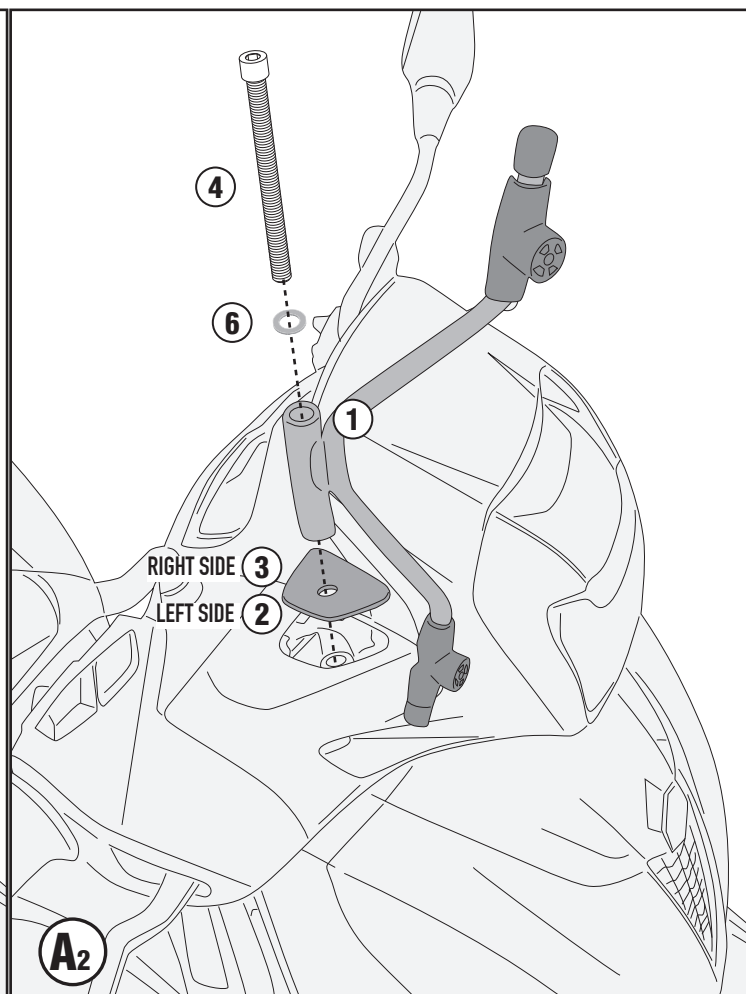
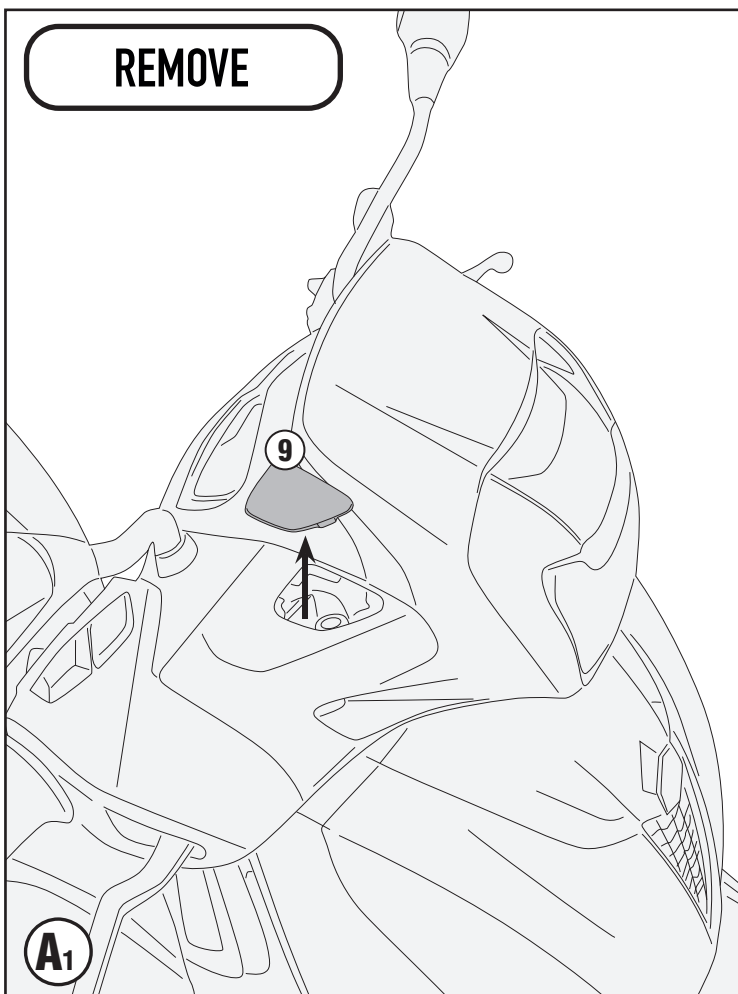

ISTRUZIONI DI MONTAGGIO - MOUNTING INSTRUCTIONS
INSTRUCTIONS DE MONTAGE - BAUANLEITUNG
INSTRUCCIONES DE MONTAJE - INSTRUÇÕES DE MONTAGEM

A5616A - A5616AK

ATTACCHI SPECIFICI PER - SPECIFIC FITTING KIT FOR - KIT DE MONTAGE SPECIFIQUE POUR
SPEZIFISCHER MONTAGEKIT FÜR - ANCLAJE ESPECÍFICO PARA - ANCORADOURO ESPECÍFICO

PIAGGIO BEVERLY 300 HPE(2021)



- ATTENZIONE : STRINGERE LE VITI SOLO DOPO AVER ULTIMATO IL CORRETTO POSIZIONAMENTO DEI SUPPORTI
- CAUTION : TIGHTEN THE SCREW ONLY AFTER SUPPORTS HAVE BEEN PLACED IN THEIR CORRECT POSITIONS.
- ATTENTION : SERRER LES VIS QUE LORSQUE LES SUPPORTS ONT ÉTÉ MISES EN POSITION CORRECTE.
- ACHTUNG : SCHRAUBE ERST DANN ANZUZIEHEN, WENN DIE STÜTZEN POSITIONIERT SIND.
- ATENCIÓN : APRETAR LOS TORNILLOS SOLO DESPUES DE HABER ULTIMADO EL CORRECTO POSICIONAMIENTO DEL SOPORTES.
- CUIDADO : APERTAR O PARAFUSO SOMENTE DEPOIS QUE APOIOS FORAM COLOCADOS NAS POSIÇÕES CORRETAS.

