

A314A - A314A

ATTACCHI SPECIFICI PER - SPECIFIC FITTING KIT FOR
KIT DE MONTAGE SPECIFIQUE POUR - SPEZIFISCHER MONTAGEKIT FÜR -
ANCLAJE ESPECÍFICO PARA - ANCORADOURO ESPECÍFICO

HONDA LEAD 110cc 2008

ISTRUZIONI DI MONTAGGIO - MOUNTING INSTRUCTIONS - INSTRUCTIONS DE MONTAGE
BAUANLEITUNG - INSTRUCCIONES DE MONTAJE - INSTRUÇÕES DE MONTAGEM

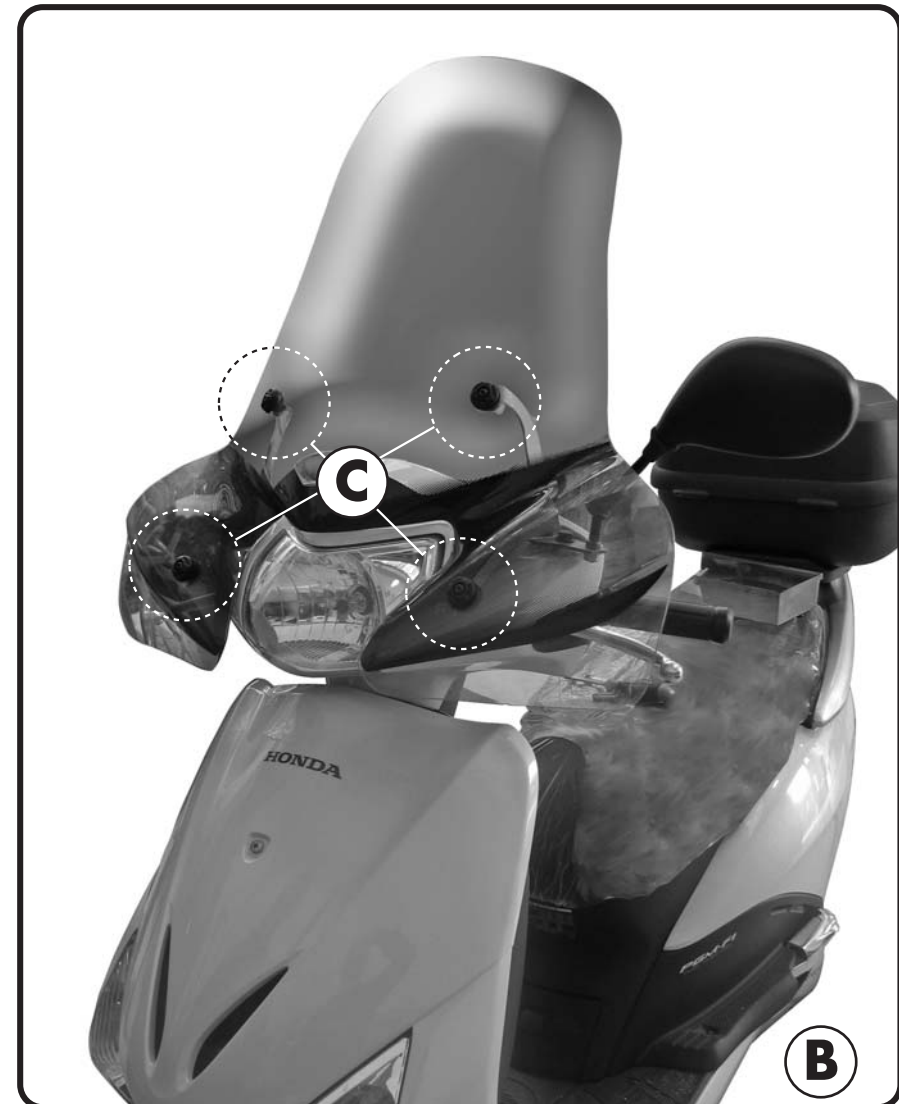
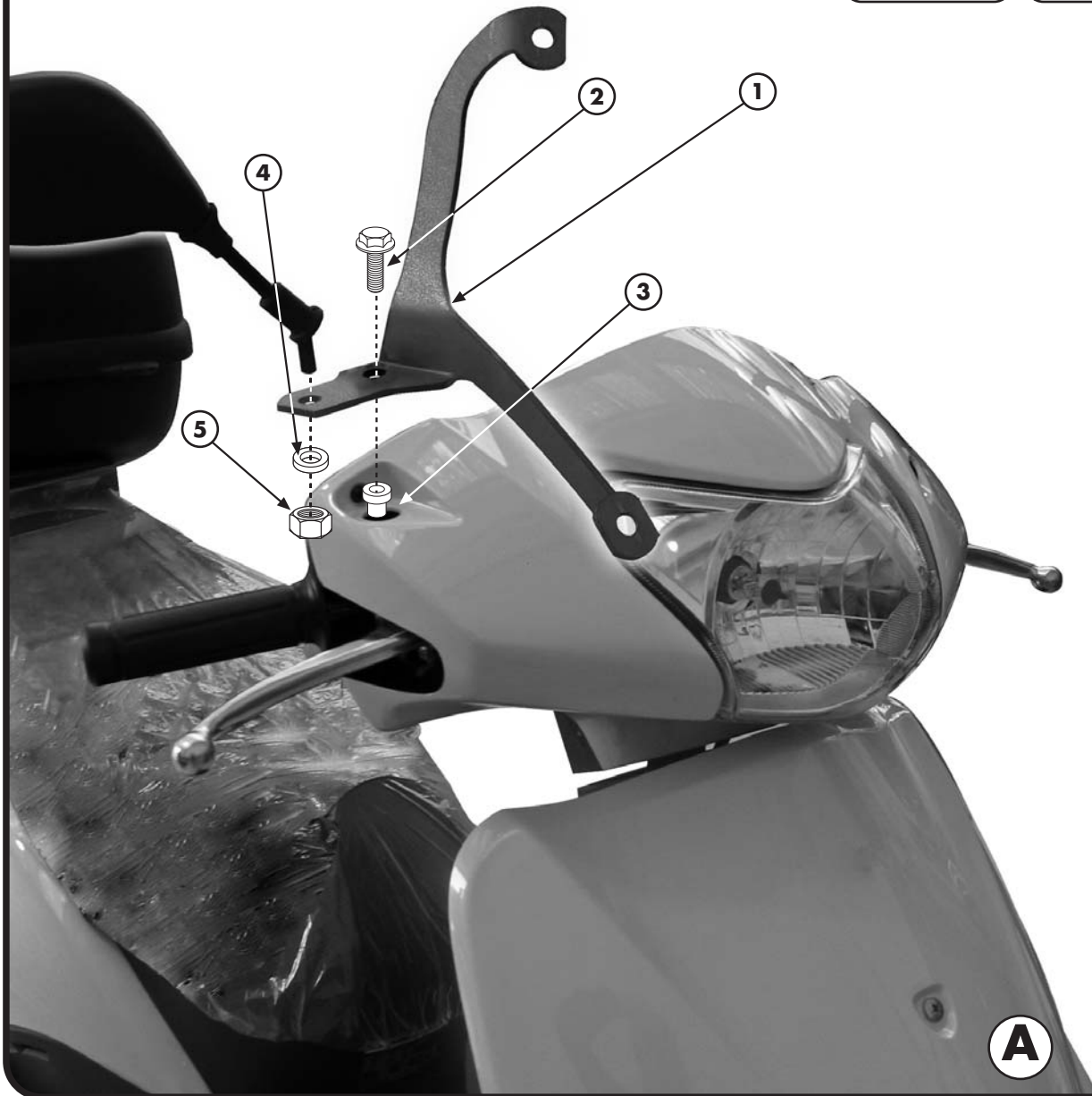
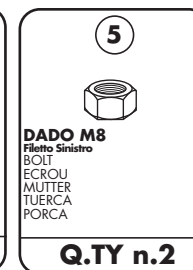
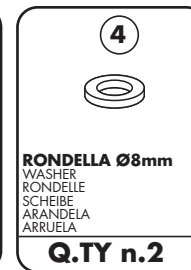
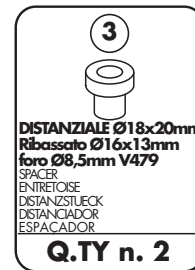
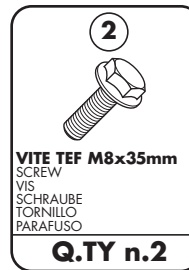

ATTACCHI SPECIFICI PER - SPECIFIC FITTING KIT FOR
 KIT DE MONTAGE SPECIFIQUE POUR - SPEZIFISCHER MONTAGEKIT FÜR -
 ANCLAJE ESPECIFICO PARA - ANCORADOURO ESPECIFICO

HONDA LEAD 110cc 2008

ISTRUZIONI DI MONTAGGIO - MOUNTING INSTRUCTIONS - INSTRUCTIONS DE MONTAGE
 BAUANLEITUNG - INSTRUCCIONES DE MONTAJE - INSTRUÇÕES DE MONTAGEMJE

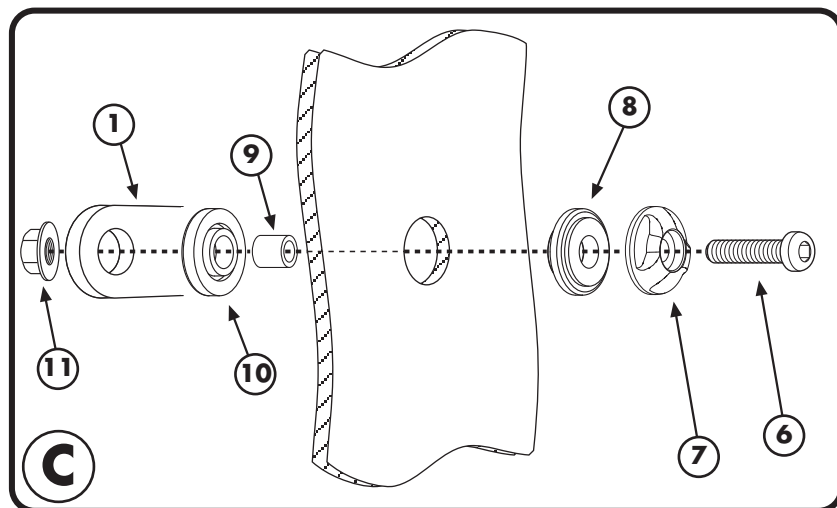

6



VITE TBEI M6x30mm
 SCREW
 VIS
 SCHRAUBE
 TORNILLO
 PARAFUSO

Q.TY n.4

7



BOCCOLA DI RITENZIONE Z1861
 PLASTIC BUSH
 DOUILLE PLASTIQUE
 PLASTIK BUCHSE
 CASQUILLO
 CONCHA

Q.TY n.4

8



GOMMINO Z1858
 FAIRLEADER
 CHAUMARD
 GUMMI
 GOMA
 BORRACHA

Q.TY n.4

9



DISTANZIALE Ø10x6mm Foro Ø6mm, V1862
 SPACER
 ENTRETISE
 DISTANZSTUECK
 DISTANCIADOR
 ESPACADOR

Q.TY n.4

10



GOMMINO Z1857
 FAIRLEADER
 CHAUMARD
 GUMMI
 GOMA
 BORRACHA

Q.TY n.4

11



DADO A.B. M6
 FLANGIATO
 BOLT
 ECROU
 MUTTER
 TUERCA
 PORCA

Q.TY n.4