

PIASTRA SPECIFICA - SPECIFIC PLATE
 PLATINE SPECIFIQUE - SPEZIFISCHE PLATTE - PLETINA ESPECÍFICA

YAMAHA MAJESTY 400 '04/'08

ISTRUZIONI DI MONTAGGIO - MOUNTING INSTRUCTIONS
 INSTRUCTIONS DE MONTAGE - BAUANLEITUNG - INSTRUCCIONES DE MONTAJE

1



SUPPORTO PIASTRA
 PLATE SUPPORT
 SUPORT PLAQUE
 PLATTEHALTERUNG
 SOPORTE PLETINA

Q.TY n.1

2



VITE TCEI M8x55mm
 SCREW M8x55mm
 VIS M8x55mm
 SCHRAUBE M8x55mm
 TORNILLO M8x55mm

Q.TY n.2

3



VITE TBEI M8x20mm
 SCREW M8x20mm
 VIS M8x20mm
 SCHRAUBE M8x20mm
 TORNILLO M8x20mm

Q.TY n.2

4

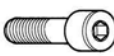

VITE TCEI M6x35mm
 SCREW M6x35mm
 VIS M6x35mm
 SCHRAUBE M6x35mm
 TORNILLO M6x35mm

Q.TY n.4

5



RONDELLA Ø8x14
 WASHER Ø8x14
 RONDELLE Ø8x14
 SCHEIBE Ø8x14
 ARANDELA Ø8x14

Q.TY n.2

6 Z622



PIASTRA
 PLATE
 PLATINE
 PLATTE
 PLETINA

Q.TY n.1

7



RONDELLA Ø6
 WASHER Ø6
 RONDELLE Ø6
 SCHEIBE Ø6
 ARANDELA Ø6

Q.TY n.4

8



DADO A.B. M6
 BOLT M6
 ECROU M6
 MUTTER M6
 TUERCA M6

Q.TY n.4

9



**DISTANZIALE f11x11mm
 foro f16,5mm
 V687**
 SPACER
 ENTRETROISE
 DISTANZSTUECK
 DISTANCIADOR

Q.TY n. 4

10 Z621



COPRIFORO
 BOLT CAP
 CACHE TROU
 STOPLOCK
 TAPA AGUJERO

Q.TY n.6

11



**RONDELLA IN GOMMA
 Z1823**
 RUBBER WASHER
 RONDELLE EN GOMME
 GUMMISCHEIBE
 ARANDELA DE GOMA

Q.TY n.4

12



RONDELLA f16x20mm
 WASHER f16x20mm
 RONDELLE f16x20mm
 SCHEIBE f16x20mm
 ARANDELA f16x20mm

Q.TY n.4

13 Z801



COPRIVITE Ø8
 SCREW CAP
 CACHE VIS
 STOPPSCHRAUBE
 TAPA TORNILLO

Q.TY n.2

14 V558



**DISTANZIALE 18x24
 foro 8,5 NERO**
 SPACER
 ENTRETROISE
 DISTANZSTUECK
 DISTANCIADOR

Q.TY n.2

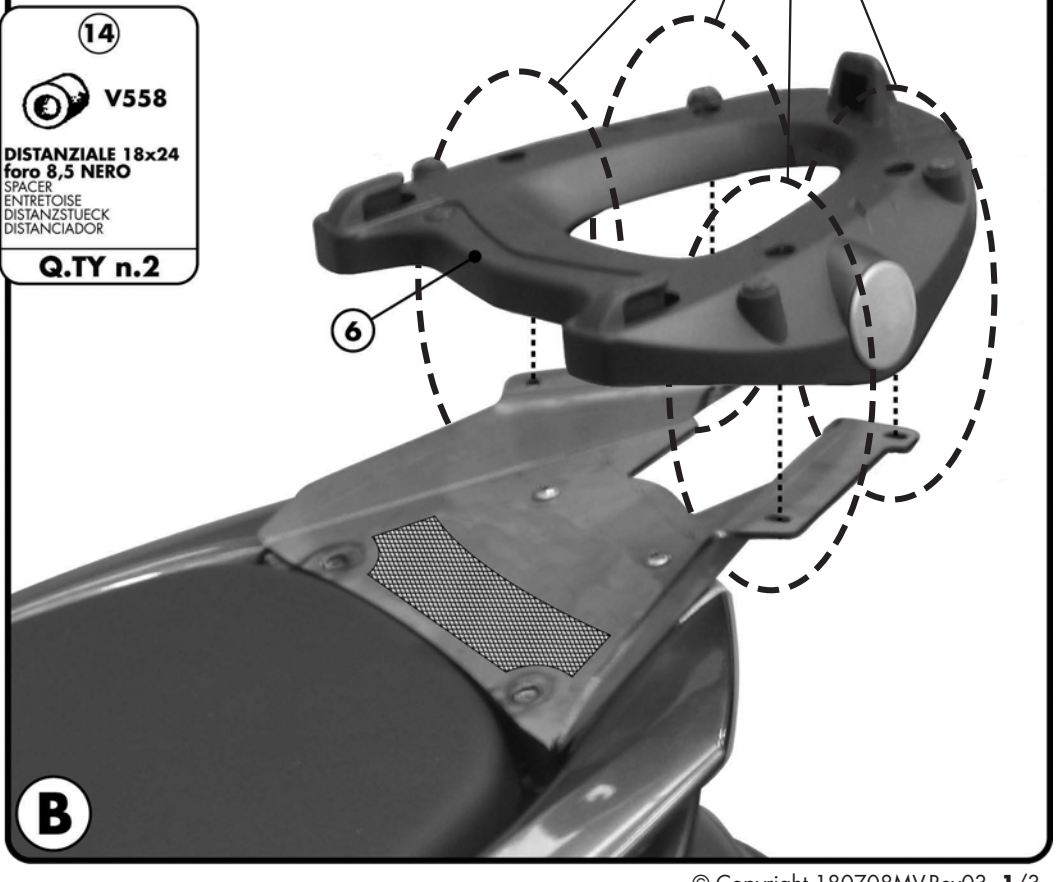
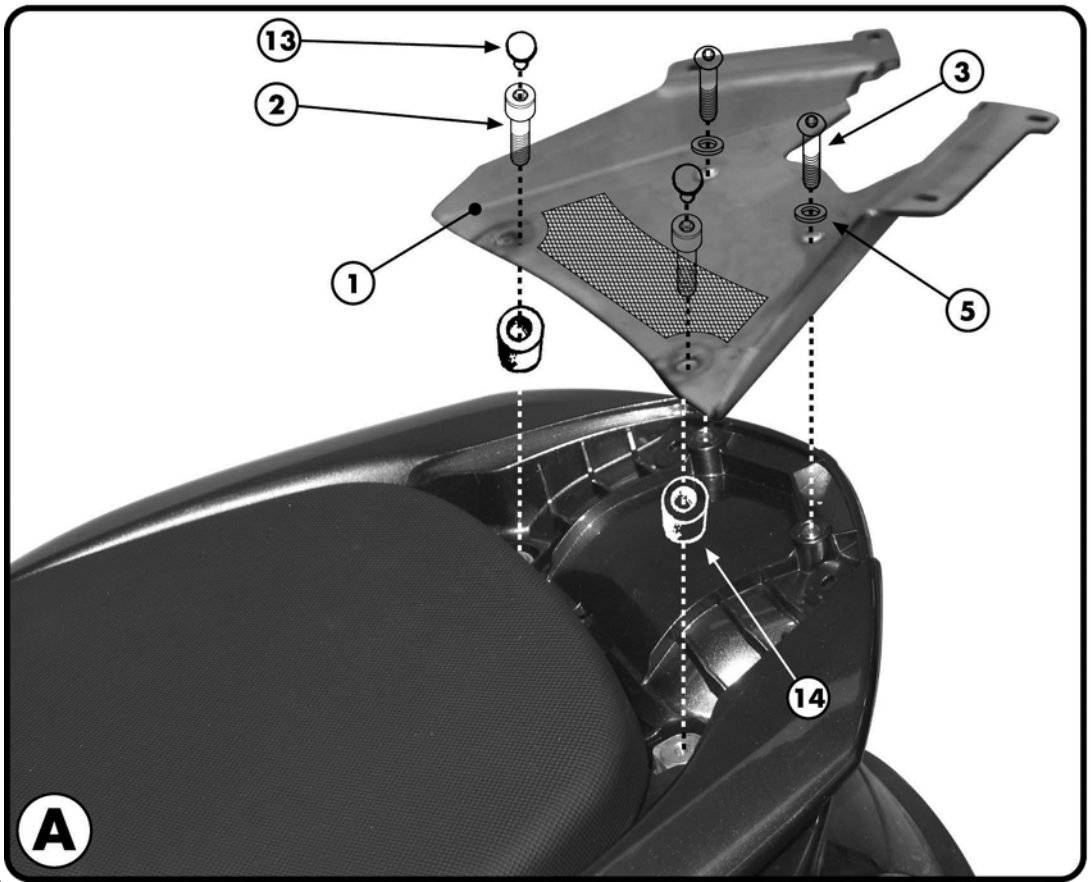

E331 - K331

PIASTRA SPECIFICA - SPECIFIC PLATE
PLATINE SPECIFIQUE - SPEZIFISCHE PLATTE - PARRILLA ESPECCEFICA

YAMAHA MAJESTY 400cc '04/'08

ISTRUZIONI DI MONTAGGIO - MOUNTING INSTRUCTIONS
INSTRUCTIONS DE MONTAGE - BAUANLEITUNG - INSTRUCCIONES DE MONTAJE

15

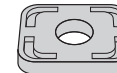

GOMMINO
Z1822
RUBBER
CAOUTCHOUC
GUMMI
GOMA

Q.TY n.4

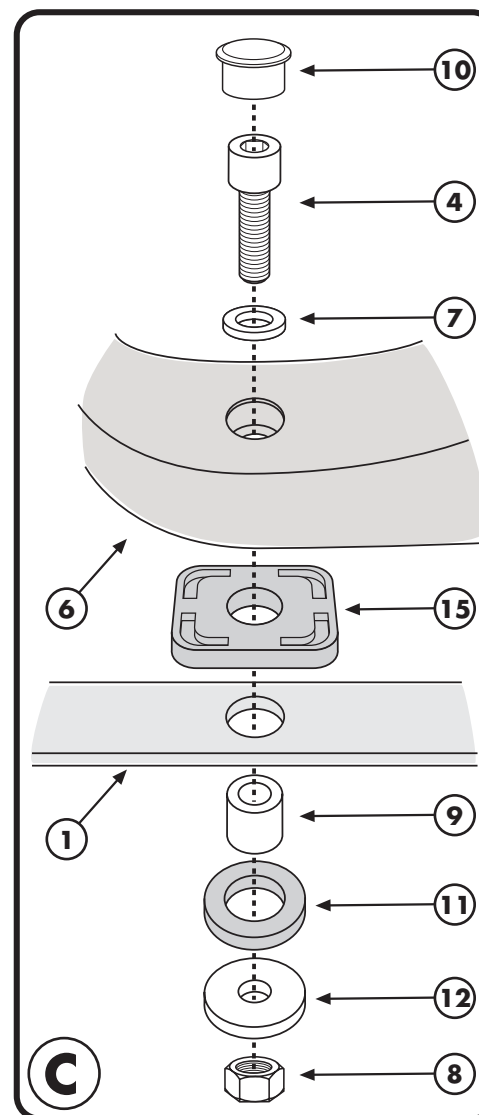

PIASTRA SPECIFICA - SPECIFIC PLATE
 PLATINE SPECIFIQUE - SPEZIFISCHE PLATTE - PLETINA ESPECÍFICA

YAMAHA MAJESTY 400 '04/'08

ISTRUZIONI DI MONTAGGIO - MOUNTING INSTRUCTIONS
 INSTRUCTIONS DE MONTAGE - BAUANLEITUNG - INSTRUCCIONES DE MONTAJE

I ISTRUZIONI DI MONTAGGIO

1. SMONTARE LA PARTE DI CARENATURA DELLA CODA DELLO SCOOTER INTERESSATA NEL MONTAGGIO;
2. FISSARE LA PIASTRA N°1 COME INDICATO IN FOTO A;
3. MONTARE LA PIASTRA N°6 COME INDICATO IN FOTO B;
4. ULTIMARE IL MONTAGGIO CONTROLLANDO CHE TUTTE LE VITI SIANO SERRATE BENE.

GB MOUNTING INSTRUCTIONS

1. REMOVE THE REAR CENTRAL FAIRING SECTION AS SHOWN IN PICTURE (A)
2. FIX THE PLATE N° 1 AS SHOWN IN PICTURE A
3. MOUNT THE PLATE N° 6 AS SHOWN IN PICTURE B
4. LASTLY CHECK THAT ALL THE SCREWS HAVE BEEN CORRECTLY TIGHTENED.

F INSTRUCTIONS DE MONTAGE

1. DEMONTER LA PARTIE DE LA COQUE ARRIERE DU SCOOTER CONCERNEE PAR LE MONTAGE;
2. FIXER LA PLAQUE N°1 COMME INDIQUE SUR LA PHOTO A;
3. MONTER LA PLATINE N°6 COMME INDIQUE SUR LA PHOTO B;
4. TERMINER LE MONTAGE EN CONTROLANT LE BON SERRAGE DE TOUTES LES VIS.

D BAUANLEITUNG

1. MONTIEREN SIE DIE HECKVERKLEIDUNG DES ROLLERS AB
2. BEFESTIGEN SIE DIE PLATTE NR. 1 WIE IM BILD A BESCHRIEBEN
3. MONTIEREN SIE DIE PLATTE NR. 6 WIE IM BILD B BESCHRIEBEN
4. ZULETZT ZIEHEN SIE ALLE SCHRAUBEN FEST.

ES

INSTRUCCIONES DE MONTAJE

1. DESMONTAR LA PARTE DEL CARENADO DEL COLÍN DEL SCOOTER NECESARIA PARA EL MONTAJE;
2. FIJAR EL SOPORTE N° 1 COMO INDICA LA FOTO A;
3. MONTAR LA PARRILLA N° 6 COMO INDICA LA FOTO B;
4. TERMINAR EL MONTAJE CONTROLANDO QUE TODOS LOS TORNILLOS ESTÉN BIEN APRETADOS.