

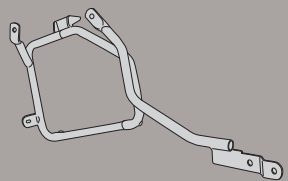





PL1111 - KL1111

PORTAVALIGIE LATERALE SPECIFICO - SPECIFIC TUBULAR SIDE-CASE HOLDER - PORTE-VALISES LATÉRAUX SPÉCIFIQUE - SPEZIFISCHES STAHLROHR-SEITENTRAEGER

PORTA MALETAS LATERALES ESPECÍFICO

HONDA NC700X (2012)

N°	Descrizione	Caratteristiche	Codice	Quantità	
1	Supporto - Support - Support Halterung - Soporte	-	-	2 (Dx,Sx)	
2	Ponte Posteriore - Rear Bridge - Pont Postérieure Verbindungsrohr - Puente Trasero	-	-	1	
3	Vite - Screw Vis - Schraube Tornillo	TEF M8x16	-	4	
4	Vite - Screw Vis - Schraube Tornillo	TEF M6x16	-	2	
5	Vite - Screw Vis - Schraube Tornillo	TCEI M8x30	-	4	
6	Dado - Bolt - Ecrou Mutter - Tuerca	Auto Bloccante Flangiato M6	-	2	
7	Dado - Bolt - Ecrou Mutter - Tuerca	Auto Bloccante Flangiato M8	-	4	
8	Particolari Inclusi Nel Kit Aggiuntivo Components Included In The Additional Fitting Kit Pièces Incluses Dans Le Kit De Vis Additionnel Die Einzelnen Teile Sind Bei Zusätzlichen Montagekit Enthalten Despieces Incluidos En El Kit De Anclajes Del Porta Maletas Añadidos	-	-	-	
9	Particolari Inclusi Nel Kit Viteria Del Monorack Components Included In The Fitting Kit Of The Monorack Pièces Incluses Dans Le Kit De Vis De El Monorack Die Einzelnen Teile Sind Bei Montagekit Der Monorack Enthalten Despieces Incluidos En El Kit De Anclajes De El Monorack				

PL1111 - KL1111

PORTAVALIGIE LATERALE SPECIFICO - SPECIFIC TUBULAR SIDE-CASE HOLDER - PORTE-VALISES LATÉRAUX SPÉCIFIQUE - SPEZIFISCHES STAHLROHR-SEITENTRAEGER

PORTA MALETAS LATERALES ESPECÍFICO

HONDA NC700X (2012)

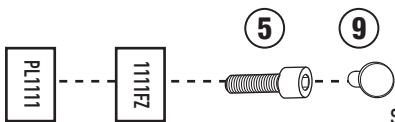
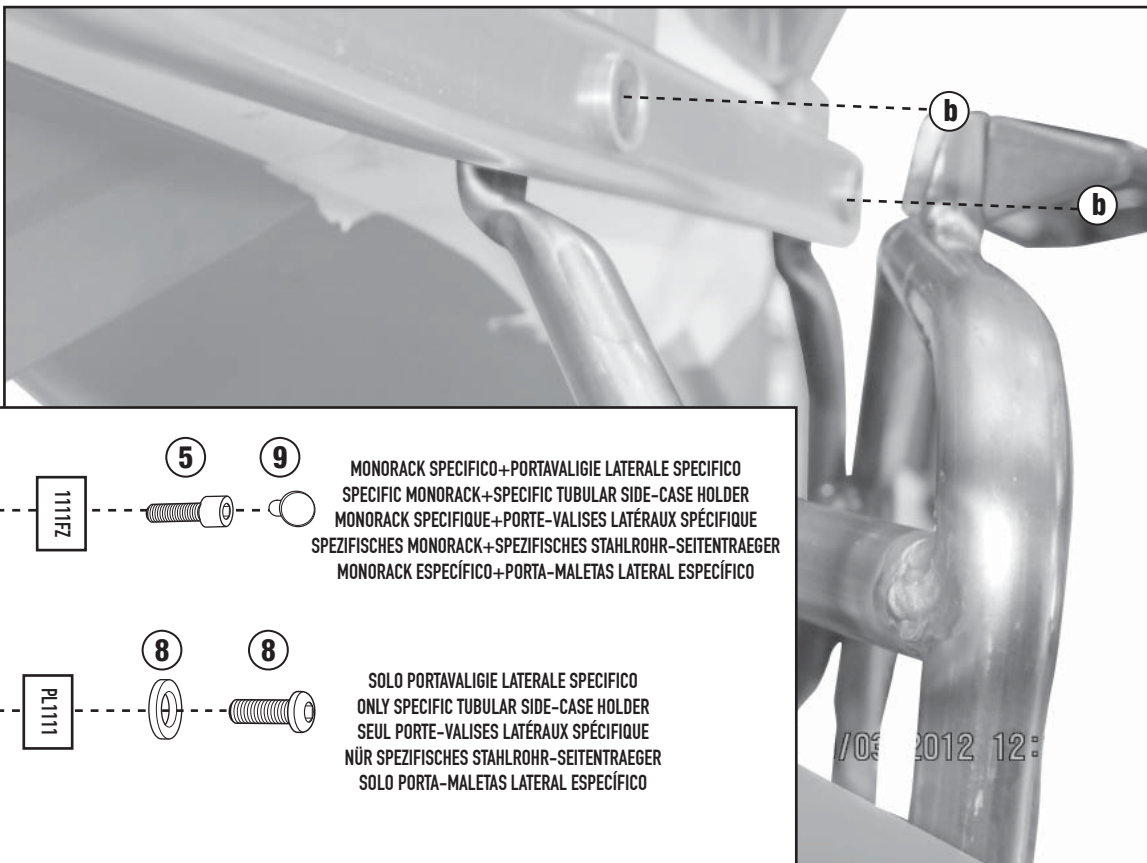
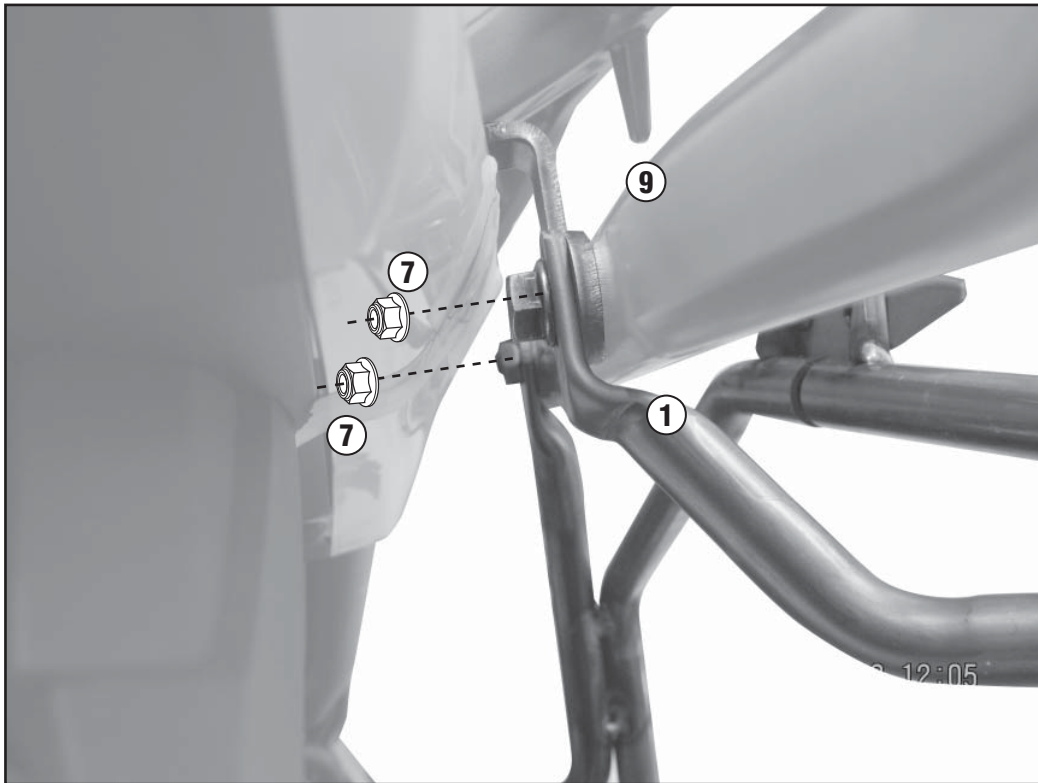

MONORACK SPECIFICO+PORTAVALIGIE LATERALE SPECIFICO
SPECIFIC MONORACK+SPECIFIC TUBULAR SIDE-CASE HOLDER
MONORACK SPÉCIFIQUE+PORTE-VALISES LATÉRAUX SPÉCIFIQUE
SPEZIFISCHES MONORACK+SPEZIFISCHES STAHLROHR-SEITENTRAEGER
MONORACK ESPECÍFICO+PORTA-MALETAS LATERAL ESPECÍFICO

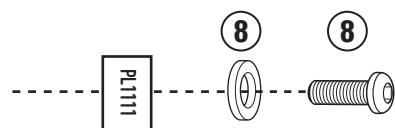

SOLO PORTAVALIGIE LATERALE SPECIFICO
ONLY SPECIFIC TUBULAR SIDE-CASE HOLDER
SEUL PORTE-VALISES LATÉRAUX SPÉCIFIQUE
NÜR SPEZIFISCHES STAHLROHR-SEITENTRAEGER
SOLO PORTA-MALETAS LATERAL ESPECÍFICO

B

PL1111 - KL1111

PORTAVALIGIE LATERALE SPECIFICO - SPECIFIC TUBULAR SIDE-CASE HOLDER - PORTE-VALISES LATÉRAUX SPÉCIFIQUE - SPEZIFISCHES STAHLROHR-SEITENTRAEGER

PORTA MALETAS LATERALES ESPECÍFICO

HONDA NC700X (2012)

