

BTZ7S-BS

BS CODE: 300695

VOLTAGE **12V**

CCA **130A**

CAPACITY 20HR **6.3Ah**

CAPACITY 10HR **6.0Ah**







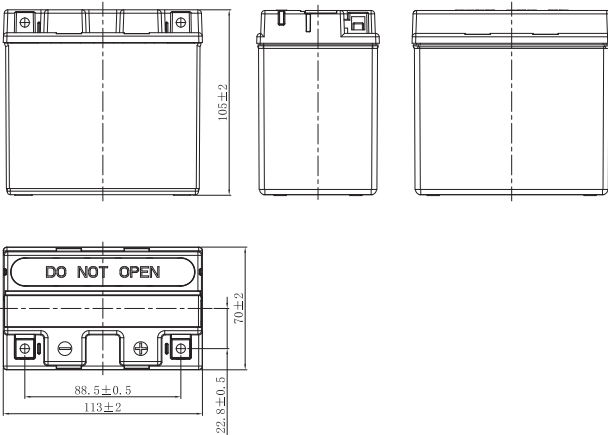

DIMENSIONS

LENGTH	113 ±2mm	4.45 ±0.08inch
WIDTH	70 ±2mm	2.76 ±0.08inch
TOTAL HEIGHT	105 ±2mm	4.13 ±0.08inch
WEIGHT	1.77 kg ±5%	3.9 lbs ±5%



MF FEATURES

-  **TO BE ACTIVATED**
AGM (Absorbent Glass Mat) technology.
-  **ACID PACK INCLUDED**
For initial filling.
-  **NO MAINTENANCE***
VRLA (Valve Regulated Lead Acid) design.
-  **TIGHTLY SEALED AFTER FILLING**
Electrolyte is held in a glass fiber mat.
-  **SUPERIOR POWER & EXTENDED CYCLE LIFE**
-  **LONG SHELF LIFE**
No need to be recharged while stocked (if not activated).

*once activated

MOUNTING ANGLE

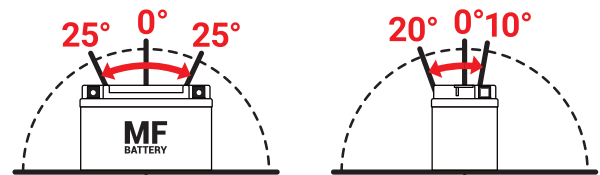

TERMINAL (mm)

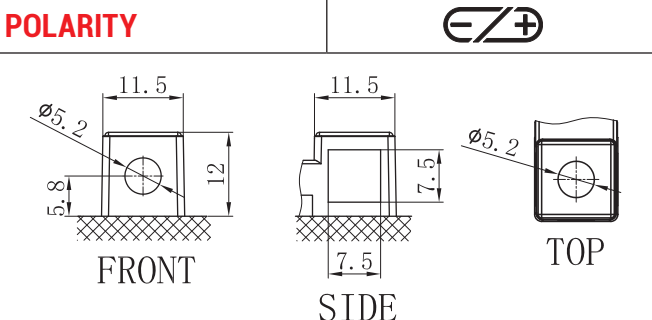

UPGRADE FOR

SLA MAX	SLA	MF	DRY
-	-	-	-